

Project: 230V-0,37+StSt+P

Projectnummer: 60019-60020-60021

Klant: Bestuuringskasten.com

Stimac B.V.
Florijn 23
5751 PC Deurne
Tel: 0493-782710
Email: info@stimac.nl
Website: www.stimac.nl

**STIMAC**

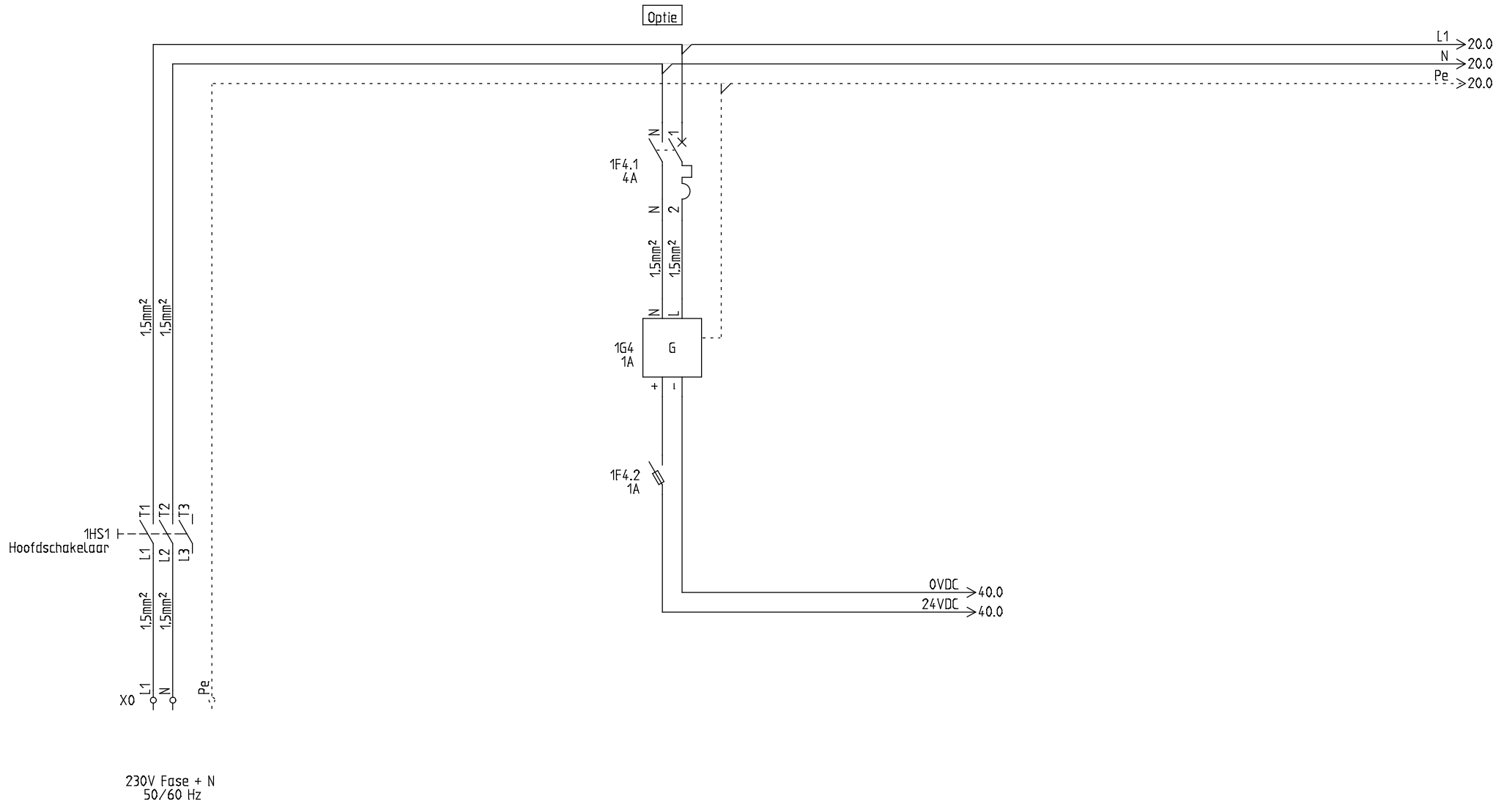

11-10-2022 13:58:53 4 9



Klant: Bestuuringskasten.com
Florijn 12

Beschrijving: Voeding

Project: 230V-0,37+StSt+P		TEK: H,G	Rev.:	Sheet: 1
Date: 27-11-2020	Function:	Location:	Total sheets: 3	Next sheet: 20

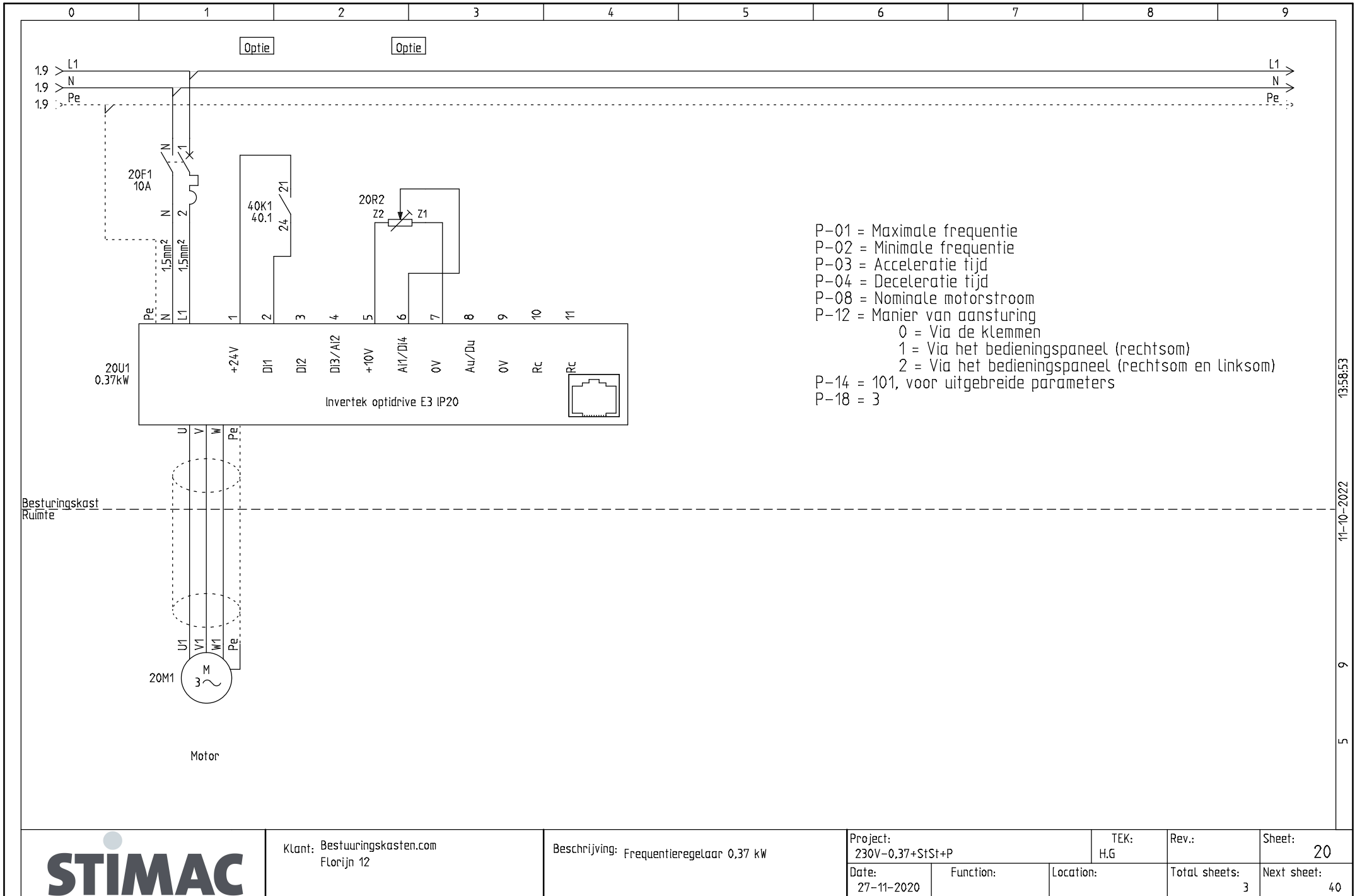

13-58,53

11-10-2022

9

5

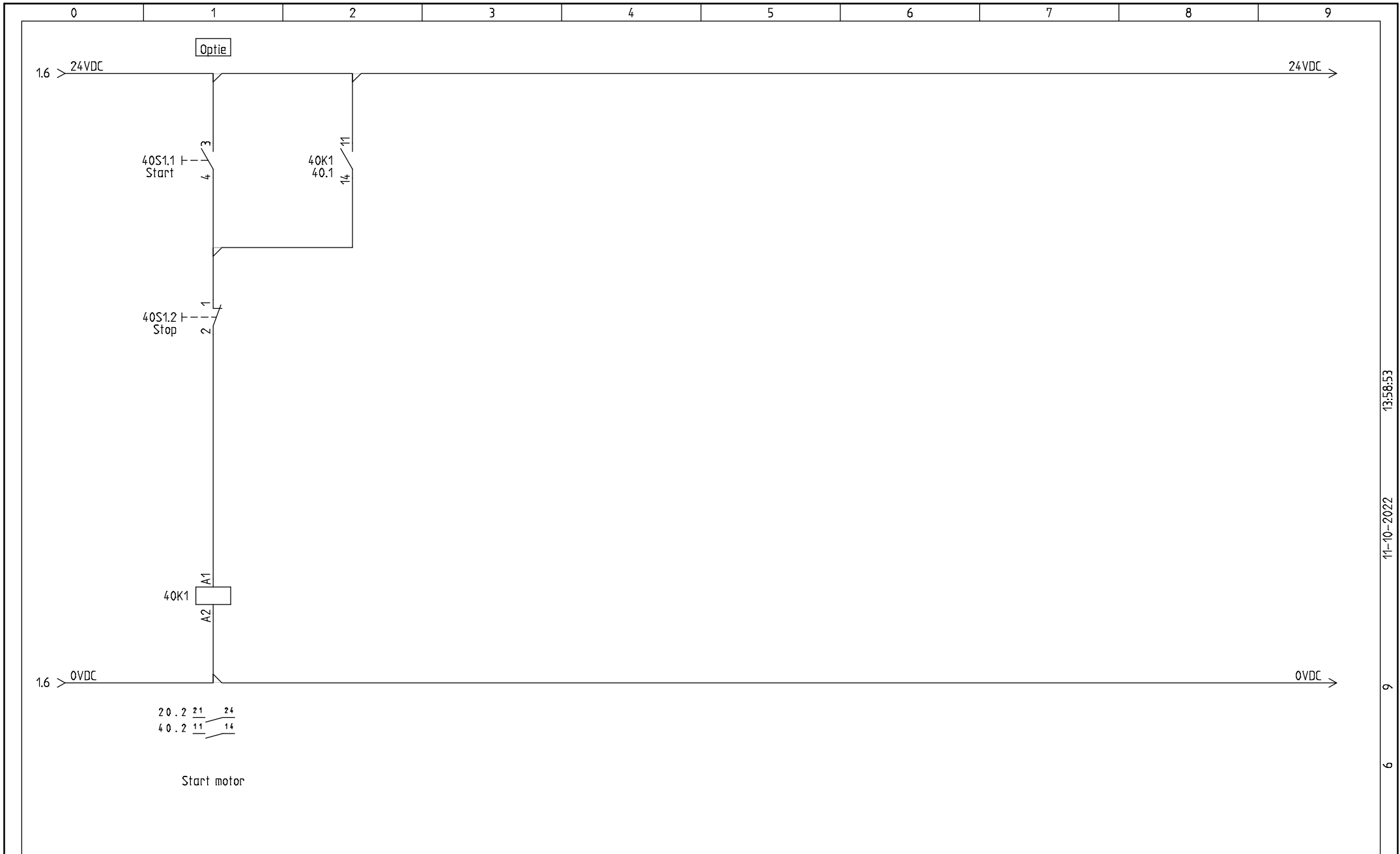

11-10-2022 13:58:53 9 6



Klant: Bestuuringskasten.com
Florijn 12

Beschrijving: Stuurstroom

Project: 230V-0,37+StSt+P		TEK: H.G.	Rev.:	Sheet: 40
Date: 27-11-2020	Function:	Location:	Total sheets: 3	Next sheet:

Paneel RVS en Staal

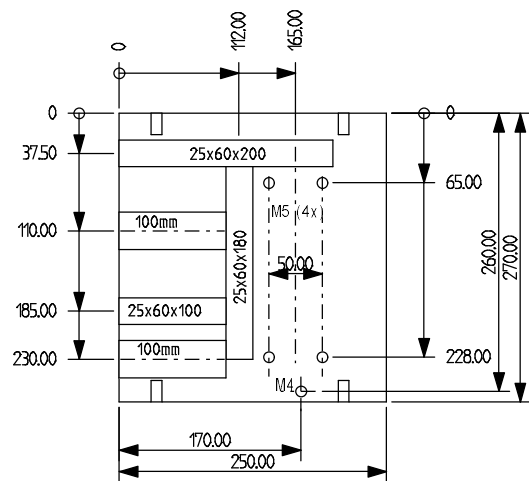

Paneel Kunststof

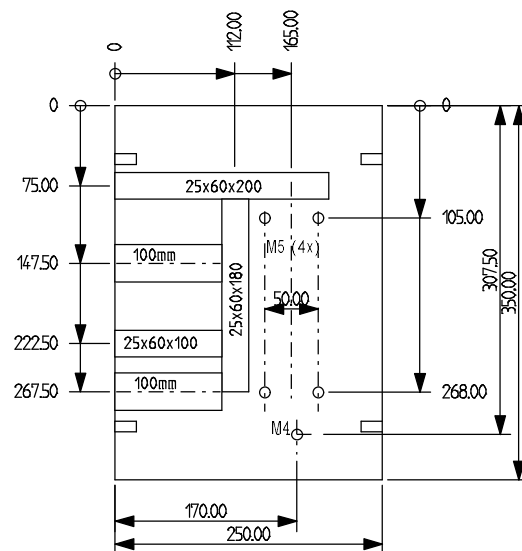

Goot= 500 mm
DIN rail = 200 mm

		Toel. afwijking		Oppervlakte	Schaal 1:5	Gewicht
		Tek. 18-2-2021		Materiaal Onderdeelnr. Model-Nr. Projectnaam		
Datum		Naam		Titel		
Norm		H.G.		230V-0,37+StSt+P		
Functie(-)		Locatie(+)		Tekeningnummer		van
Ref.		Verandering	Datum	Naam	1	2
Orig.		Ver. v.:		Ver. d.:		Bl.

Bouwgrootte 1

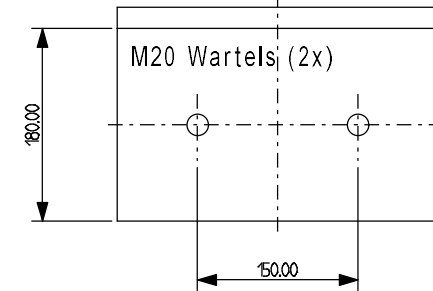
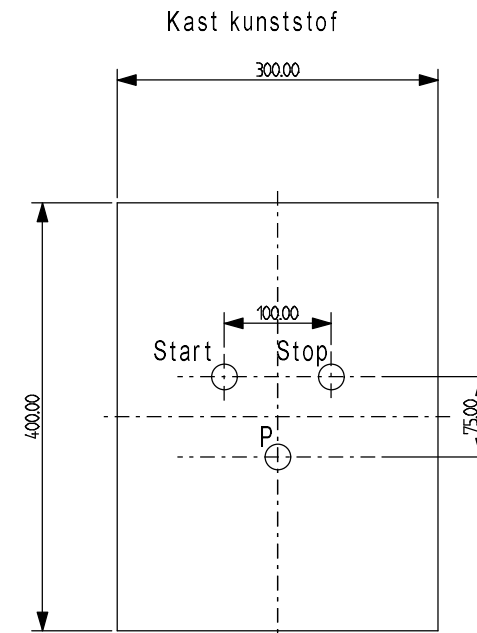
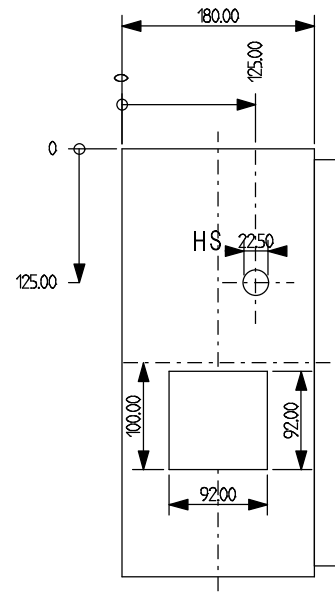
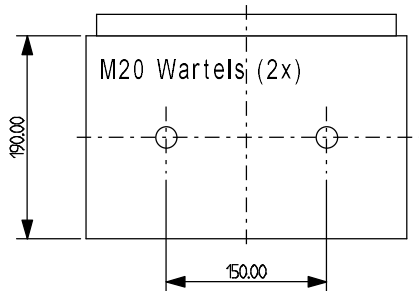
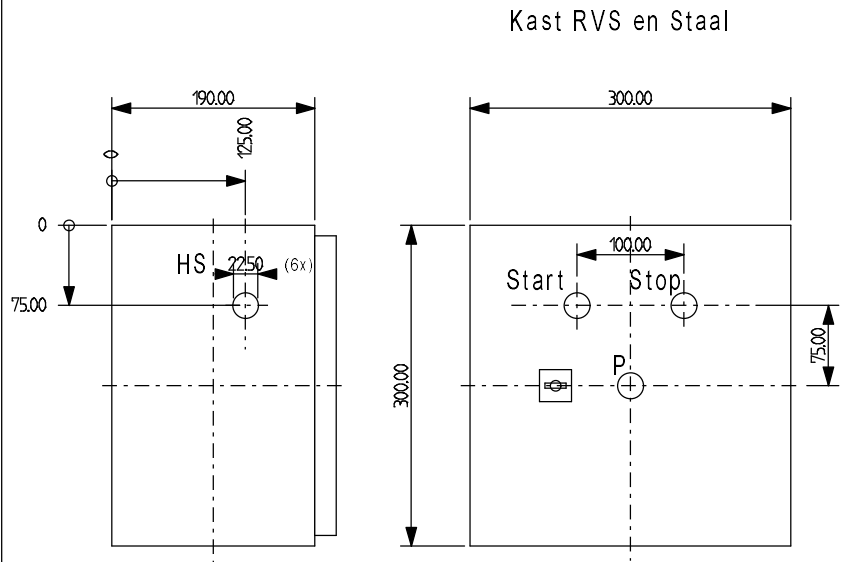

				Toel. afwijking		Oppervlakte		Schaal 1:5		Gewicht	
				Tek. 17-2-2021		Datum		Naam		Materiaal Onderdeelnr. Model-Nr.	
				Gepr.		Norm		H.G.		Titel	
				Functie(-)		Locatie(+)		Tekeningsnummer		van	
				Ref.		Verandering		Datum		Naam	
				Orig.		Ver. v.:		Ver. d.:		Bl.	
								230V-0,37+StSt+P		16	
										2	
										BL.	

BOM (Stuklijst)

Aantal	Artikel nr. Stimac	Fabrikant	Type omschrijving
1.00	21954	IN30120	Frequentieregelaar - 0,37 kW - 230V - IP20 - type
1.00	12022		Din-rail per meter (35mm)
1.00	12104		Mantelleiding Lapp 3x1,5 mm ²
4.00	12506		Resopal
1.00	20005		Installatieautomaat C4A 1P+N
1.00	20018		Hulprelais compleet
1.00	20034		Railklem WDU2,5 beige
2.00	20035		Railklem WPE2,5 geel/groen
2.00	20040		Railklem sluitplaat WAP2,5-10
1.00	20041		Railklem eindsteun codering ZEW35/2 beige
1.00	20091		Stekker 230V
2.00	20103		Wartelmoer M20 kunststof
1.00	20143		Drukknop rood - ZB4BA4
3.00	20145		Railklem eindsteun EW35
2.00	20242		Wartel M20 kunststof
1.00	20243		Drukknop groen - ZB4BA3
1.00	20245		Hulpcontactblok 1x nc & adapter ZB4BZ102
1.00	20255		Railklem zekeringhouder EWSI6
1.00	20256		Hulpcontactblok 1x no & adapter ZB4BZ101
1.00	20306		Railklem WDU2,5 blauw
2.00	20459		Beschermkap tbv drukknoop laag model
1.00	20724		Potentiometer - type M22-R10K
1.00	20758		Hoofdschakelaar zwart/grijs 2P
1.00	21435		Voeding 24Vdc/1,0 A
1.00	21947		Glaszekering - 1A - 5x20 - traag
1.00	22003		Installatieautomaat C10A 1P+N
1.00	23132		Draadgoot 60x25 mm
1.00	24553		EMC-klem 3-8 mm

Plottedatum: 11-10-2022
 Plottijd: 13:58:53
 van: 9
 Plottijd: 9



Stuklijst

Projectnaam:
230V-0,37+StSt+P

Tekening Nr.:

Corr.:

Tek.:

Datum:

Functie:

Locatie:

Blad:
1

Van :
1